



OR Catalog

2022

April 2022



SHARE YOUR IDEA



PARTNER WITH TZ



EARN ROYALTIES

INNOVATION STARTS WITH YOU

www.tzmedical.com



TZ Medical
Sparked by your ideas



TZ Medical

Sparked by your ideas

TABLE OF CONTENTS

The TZ Medical Story	_____	3
Sparked By Your Ideas	_____	4
Neurosurgery	_____	5
Safety & Efficiency	_____	9
Patient Positioning	_____	12
Defibrillation Electrodes	_____	24
Item Number Index	_____	28

TZ Medical Inc.

17750 SW Upper Boones Ferry Rd. #150
Portland, OR 97224
Office: 800.944.0187 Fax: 503.639.0239
www.tzmedical.com

THE TZ MEDICAL STORY

When TZ Medical founder, Tom Tribou, sat planning his new company in a Portland coffee shop in 1990, he made two bedrock decisions. The first was that TZ Medical would turn the paradigm of medical equipment manufacturing on its head by taking the time to listen to medical professionals on the front lines, and find out what they needed, before huddling with its own engineers. The second decision was that pricing should be at the value level, to ensure that these bright ideas would make their way into the hands of critical-care medical professionals faster.

Over the years these ideas have served the company well. What was once a small collection of critical-care devices has grown into a whole family of medical products, sparked by your ideas. With products sold across the nation and all over the world, TZ Medical has built a solid reputation for itself on the first two decisions laid out in the company's infancy.

Today, the TZ Medical team is recognized as a group that creates products based on input from professionals in some of the finest medical facilities throughout the world. These innovative health professionals have often helped supply the missing piece of a puzzle, revealed the essence of a problem, or posed the perfect "what if" question in order to help solve a dilemma, and facilitate practical solutions.

Between our dedication to listening, and our firm belief in affordable pricing, it's no wonder that TZ Medical has been, and will continue to be, a lasting leader in the medical device manufacturing world.



OUR MISSION STATEMENT

Our mission is to design, manufacture, and deliver products that meet and exceed the needs and expectations of each customer. We will sustain our vision and mission by constantly seeking renewal via continuous education and learning, and the application of new technologies and best business practices. We will do business as model individual and corporate citizens in our local and international communities. We will "play to win", acting with absolute honesty, integrity, and fairness in the way we conduct our business and the way we live our lives.



INNOVATION STARTS WITH YOU



SHARE YOUR IDEA



PARTNER WITH TZ



EARN ROYALTIES

SPARKED BY YOUR IDEAS

At TZ Medical, we take pride in our practice of partnering with physicians, nurses, and technologists to help bring new product ideas to market. With decades of practical experience in design, manufacturing, and engineering, we excel in transforming your innovative ideas into product realities. Our most reliable and valuable asset to improving healthcare is YOU.

FIND OUT MORE



800.944.0187



tzmedical.com



TZ Medical
Sparked by your ideas



TZ Medical
Sparked by your ideas

NEUROSURGERY

TZ Medical's line of neurosurgical products offers distinct advantages over the competition. Our titanium distraction pins for anterior cervical fusion are stronger, sharper, and safer than competing pins, and all of our neurosurgical products are compatible with the most commonly used surgical systems to give you complete surgical confidence.

Distraction Pins • Skull Pins • Suction Tips

DISTRACTION PINS



TZ Medical
Sparked by your ideas

Ultimate Strength Comparison

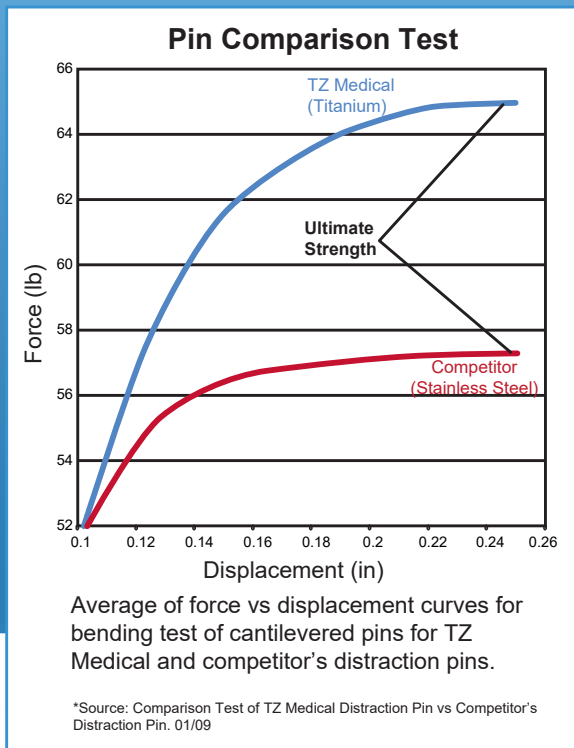

Better ultimate strength means better *performance and safety.*

Thread Comparison

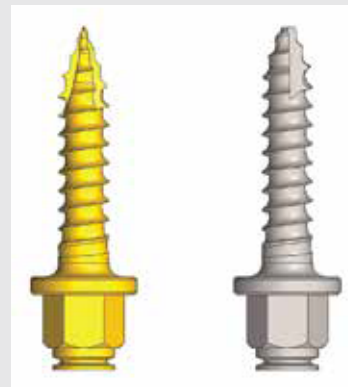

TZ Medical Titanium Distraction Pin Stainless Steel Distraction Pin



Item Number	Description	UOM
DP-12-TB	12mm Titanium Distraction Pin Blue	Box of 10
DP-14-TY	14mm Titanium Distraction Pin Yellow	Box of 10
DP-16-TG	16mm Titanium Distraction Pin Green	Box of 10
DP-18-TP	18mm Titanium Distraction Pin Purple	Box of 10

Features

- Triple fluted design for easier insertion into bone
- Wider diameter than typical distraction pins
- Color-coded sizes for faster identification
- Made with 100% titanium
- Cost effective
- Safer and sturdier than pins made from stainless steel
- Compatible with all current ACF systems



Distraction Pin Accessories

DP-S	Caspar Screwdriver Universal
DP-72-CDR	Caspar Distractor Right
DP-74-CDL	Caspar Distractor Left



SKULL PINS

TZ Medical Skull Pins are a disposable solution to cranial stabilization. The stainless steel skull pins are inserted into the skull clamp to fixate the patient's head during surgery. The pins are packaged sterile in a pack of three, and come with a protective cap, making them safe and easy to handle.



Features

- Cost effective
- Improves cranial stabilization
- Safe and easy to handle
- Sharp and durable stainless steel
- Works with existing skull clamps

Item Number	Description	UOM
SP-001	Adult, Stainless Steel Skull Pins	Box of 10 sets

SUCTION TIPS



TZ Medical
Sparked by your ideas

TZ Medical's single-use Suction Tips provide optimal control when removing fluid and debris from confined surgical sites. With a wide variety of sizes and lengths, each suction tip is ergonomically designed with a control valve on the handle allowing the operator to regulate the intensity of the suction from a convenient location. The malleability of the aluminum shafts provides better positioning and can be manipulated into multiple different angles. The suction tubes also feature a thin wire or stylette that can be used to remove trapped tissue or debris and provide support for the flexible shaft.

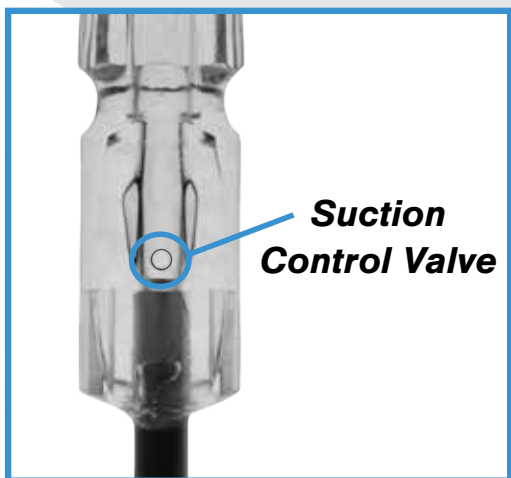
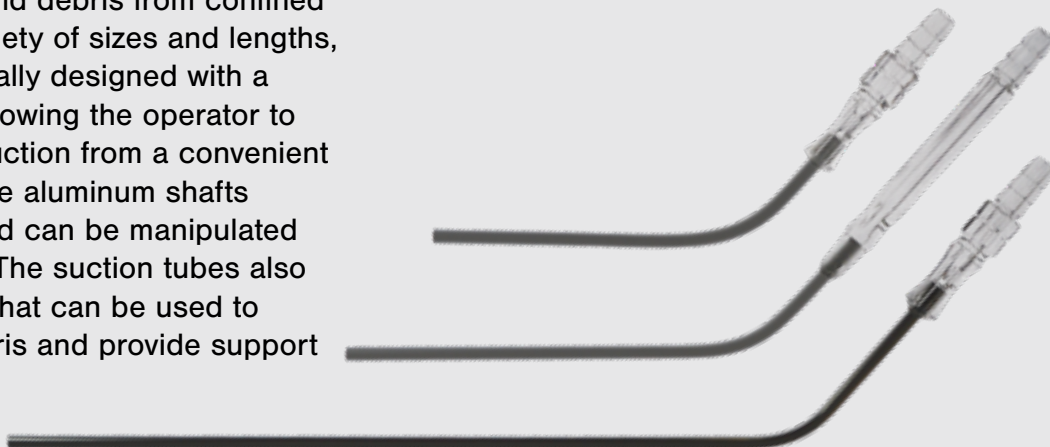

Features

- Single-use and sterile to prevent cross-contamination
- Malleable aluminum shaft provides optimal flexibility and can be molded into any desired position
- All suction tips come with a stylette or thin rod to clear any trapped tissue or debris and prevent obstruction
- Built-in control valve on the handle allows for continuous or intermittent control of suction
- Multiple French sizes and lengths available

Item Number	Description	UOM
-------------	-------------	-----

STIP-1011-08	Frazier Suction Tip - 6F, 8 cm	Box of 50
STIP-1011-11	Frazier Suction Tip - 6F, 11 cm	Box of 50
STIP-1013-08	Frazier Suction Tip - 8F, 8 cm	Box of 50
STIP-1013-11	Frazier Suction Tip - 8F, 11 cm	Box of 50
STIP-1015-08	Frazier Suction Tip - 10F, 8 cm	Box of 50
STIP-1015-11	Frazier Suction Tip - 10F, 11 cm	Box of 50
STIP-1015-23	Frazier Suction Tip - 10F, 23 cm	Box of 50
STIP-1017-08	Frazier Suction Tip - 12F, 8 cm	Box of 50
STIP-1017-11	Frazier Suction Tip - 12F, 11 cm	Box of 50
STIP-1017-23	Frazier Suction Tip - 12F, 23 cm	Box of 50
STIP-1019-08	Frazier Suction Tip - 14F, 8 cm	Box of 50
STIP-1019-11	Frazier Suction Tip - 14F, 11 cm	Box of 50
STIP-1019-23	Frazier Suction Tip - 14F, 23 cm	Box of 50





TZ Medical
Sparked by your ideas

SAFETY & EFFICIENCY

TZ Medical's line of Safety and Efficiency products are designed to simplify and enhance staff and patient safety with new technology that improves ergonomics, comfort, and communication to provide an optimal user experience.

Pro11 Headset • OR Anti-Fatigue Mats

PRO11 HEADSET SYSTEM



TZ Medical
Sparked by your ideas

The TZ Medical Pro11 Headset System enables teams to talk hands-free in the Cath Lab and EP Lab and adjacent rooms - no raised voices or straining to hear, just clear, calm communication between every member of the team, reducing stress and creating a better working environment. The system has full connectivity with external broadcast and audiovisual streaming facilities, enabling the physician to participate real-time in remote broadcasts and seminars. Using high-quality DECT frequencies, multiple systems can be used in the same premises without interference.



Item Number	Description	UOM
-------------	-------------	-----

TZ-Q-P11BS	Pro11 Base Station	1 Each
TZ-Q-P11CH	Pro11 Charger	1 Each
TZ-Q-P11HS	Pro11 Headset (battery and headband included)	1 Each

Item Number	Description	UOM
-------------	-------------	-----

TZ-Q-P11BAT	Battery for Headset	1 Each
TZ-Q-P11HB	Headband for Headset	1 Each
TZ-Q-P11NB	Neckband for Headset	1 Each
TZ-Q-RH7HC	Hygiene Covers	Box of 100
TZ-Q-RH7EC	Ear Cushions	Box of 10
TZ-Q-P10SHELF	Battery Charger Shelf	1 Each





ANTI-FATIGUE MATS

Reduce injuries while improving productivity and safety

OR Anti-Fatigue Mats are scientifically engineered with conforming gel and supportive foam to provide the ultimate in comfort and support to surgeons, nurses, and technicians. Mats are water-resistant, easy to clean, and provide the proper friction level for damp or dry surgical booties.

18"x24"

20"x32"

20"x48"

Available in 4 standard sizes.

30"x72"

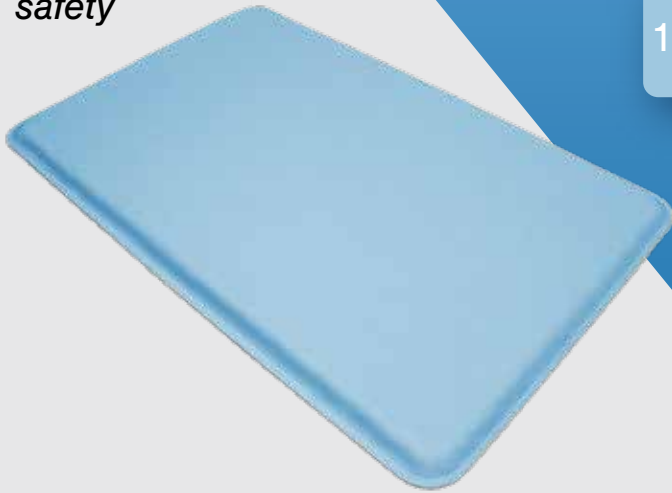

Features



- Reduces and prevents physical discomfort and fatigue
- Properly conforms and supports feet while promoting proper circulation
- Relieves pressure and restores energy while standing
- Improve comfort and ergonomics during procedures
- Reduce the number of stretches and postural changes
- Improve post-operative discomfort and energy
- Promote proper posture while diminishing back, knee and foot discomfort
- Improve performance and reduce the margin of error

Item Number	Description	UOM
GP-18X24	OR Durable 3/4" Thick Bio-Foam® Size 18X24, Blue	1 Each
GP-20X32	OR Durable 3/4" Thick Bio-Foam® Size 20X32, Blue	1 Each
GP-20X48	OR Durable 3/4" Thick Bio-Foam® Size 20X48, Blue	1 Each
GP-30X72	OR Durable 3/4" Thick Bio-Foam® Size 30X72, Blue	1 Each



PATIENT POSITIONING

TZ Medical's line of patient positioning products offers a variety of options to safely and effectively position patients for any type of hospital procedure. Whether you need positioning aids, or need to secure excess patient tissue, we have you covered.

PRS-02 ● PRS-04 ● PRS-06 ● PRS-09 ● SoftGels
Comfort Halo ● Comfort Cradle



2 Pad, 1 Strap System

The TZ Medical Pannus Retention System is a hook and loop pad and strap system designed to safely and effectively retain excess tissue for high BMI patients. It can be used as a patient positioning tool for a variety of procedural tasks, including gaining femoral access for heart caths and TAVR's, and deflecting tissue to access pacemaker/ICD implant pockets.



2 - 5.5" x 7.5" Pads



1 - 96" Strap

Intended for skin applications, the proprietary adhesive on the pads is residue-free and minimizes the risk of skin tears and degradation typically seen with the use of tape and competing products. Additionally, the product can be adjusted after application, giving clinicians complete control over how their patients are positioned.

Features

- Hypoallergenic, latex and residue free
- Adhesive pads are designed to reduce damage to the skin
- Ideal for groin access, anterior hip procedures, and more!
- Completely adjustable system - will fit any sized patient
- Can be applied in less than 1 minute
- Easy to reposition after application
- No additional products are required



Item Number	Description	UOM
-------------	-------------	-----

CZ-PRS-02

Pannus Retention System
2 Pad, 1 Strap System

Box of 10



4 Pad, 2 Strap System

The TZ Medical Pannus Retention System is used to safely and effectively position and support excess tissue, allowing optimal access to the procedure site. Easily applied in one minute, the Pannus Retention System is designed to maintain patient comfort while allowing patient positioning from any angle. The device consists of four adhesive pads and two medical-grade hook & loop straps that can be adjusted after application. Intended for skin applications, the proprietary adhesive on the pads is residue-free and minimizes the risk of skin tears and degradation typically seen with the use of tape and competing products.



4 - 5.5" x 7.5" Pads

2 - 48" Strap



Safely retains large amounts of tissue



Features

- Hypoallergenic, latex and residue free
- Adhesive pads are designed to reduce damage to the skin
- Ideal for High-BMI Cesarean Sections, Trans Aortic Valve Replacements (TAVR), Anterior Hips, Hemorrhoidectomies, and more!
- Completely adjustable system - will fit any sized patient
- Can be applied in less than one minute
- Easy to reposition after application
- Sterile and designed for surgical procedures

Item Number

Description

UOM

CZ-PRS-04

Pannus Retention System
4 Pad, 2 Strap System, Sterile

Box of 10



4 Pad, 2 Strap System



4 - 5.5" x 7.5" Pads

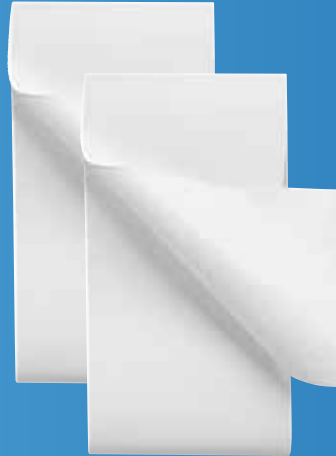

2 - 96" Straps

The PRS™ Cervical Spine Retention System is a simple and safe solution to effectively position the patient for optimal access and better imaging. Packaged with 4 adhesive pads and 2 (8ft) straps, the Cervical Spine Retention System enhances imaging capabilities of the cervical spine by deflecting and positioning the patient's shoulders down towards the foot of the bed. The large surface area of the pads combined with latex-free, hypoallergenic adhesive reduces skin integrity issues often caused by medical grade tape and alternative adhesives.



Features

- Ideal shoulder deflection for cervical fusion
- Eliminates risk of joint injury caused by pulling wrist restraints for deflection
- PRS will not release on its own during procedure
- Adhesive pads are designed to reduce damage to the skin
- Truly one-size-fits-all

Item Number	Description	UOM
-------------	-------------	-----

CZ-PRS-06

Cervical Spine Retention System
4 Pad, 2 - (96") Strap System

Box of 10

PRS - LUMBAR SPINE RETENTION SYSTEM



TZ Medical
Sparked by your ideas

9 Pad, 3 Strap System

The PRS™ Lumbar Spine Retention System provides an optimal solution for safely positioning patients during lateral spine procedures. Packaged with 9 adhesive pads and 3 (8ft) straps, this easy-to-use system creates 3 anchor points on the patient and both sides of the procedure table, securing the patient comfortably on their side. Using micro hook & loop technology, the Lumbar Spine Retention System can be readjusted at any time to ensure optimal positioning and patient comfort. The large surface area of the pads combined with latex-free, hypoallergenic adhesive reduces skin integrity issues often caused by medical grade tape and alternative adhesives.



9 - 5.5" x 7.5" Pads

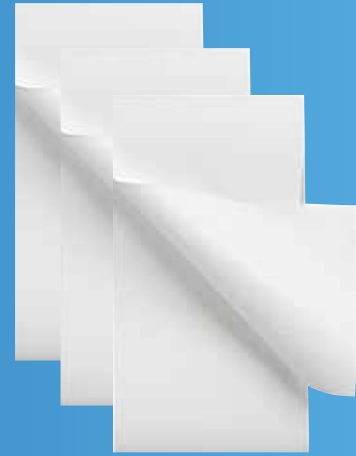

3 - 96" Straps

Features

- Reduces patient set up time
- Easily adjustable for patient repositioning
- Safer for patient - PRS will not release unexpectedly
- Adhesive pads are designed to reduce damage to the skin
- Will not leave adhesive residue on equipment
- Hypoallergenic and latex free



Item Number

Description

UOM

CZ-PRS-09

Lumbar Spine Retention System
9 Pad, 3 - (96") Strap System

Box of 10



The TZ Medical SoftGels provide superior cushioning and positioning, ensuring optimal exposure to the surgical site.



Features

- Reduces skin changes and pressure induced soreness
- Allows for correction to airway management
- Increases patient positioning stability
- Washable and reusable for any surgical procedure
- Allows for easy exposure to surgical site, providing optimal physiological safety for the patient





Item Number	Description
TZ-GELDA	Adult Gel Donut 8"OD x 3"ID x 1.75"H
TZ-GELDA-3	Extra Deep Donut 8"OD x 3"ID x 3"H
TZ-GELPD	Pediatric Donut 5.5"OD x 2.25"ID x 1.25"H
TZ-GELND	Neonatal Donut 3.07"OD x 1.68"ID x 0.81"H
TZ-GELHRS	Adult Horseshoe Donut 8"OD x 3"ID x 1.75"H
TZ-GELPHR	Pediatric Horseshoe Donut 5.5"OD x 2.25"ID x 1.25"H
TZ-GELSHP	Supine Headrest 11"OD x 9.5"ID x 2.625"H
TZ-GELHDP	Head Pad 11"OD x 9.5"ID x 3.5"H



TZ-GELDA



TZ-GELDA-3



TZ-GELPD



TZ-GELND



TZ-GELHRS



TZ-GELPHR



TZ-GELSHP



TZ-GELHDP





TZ-GELPP10



TZ-GELPP14



TZ-GELPP18



TZ-GELCR4-12



TZ-GELCR4-16



TZ-GELCR4-20



TZ-GELCR6-12



TZ-GELCR6-16



TZ-GELCR6-20

Item Number	Description
TZ-GELPP10	Gel Patient Positioner 10" x 4.5" x 2" (Sandbag Style)
TZ-GELPP14	Gel Patient Positioner 14" x 4.5" x 2" (Sandbag Style)
TZ-GELPP18	Gel Patient Positioner 18" x 4.5" x 2" (Sandbag Style)
TZ-GELCR4-12	Flat Bottom Gel Chest Roll 12" x 4" x 4"
TZ-GELCR4-16	Flat Bottom Gel Chest Roll 16" x 4" x 4"
TZ-GELCR4-20	Flat Bottom Gel Chest Roll 20" x 4" x 4"
TZ-GELCR6-12	Flat Bottom Gel Chest Roll 12" x 6" x 6"
TZ-GELCR6-16	Flat Bottom Gel Chest Roll 16" x 6" x 6"
TZ-GELCR6-20	Flat Bottom Gel Chest Roll 20" x 6" x 6"



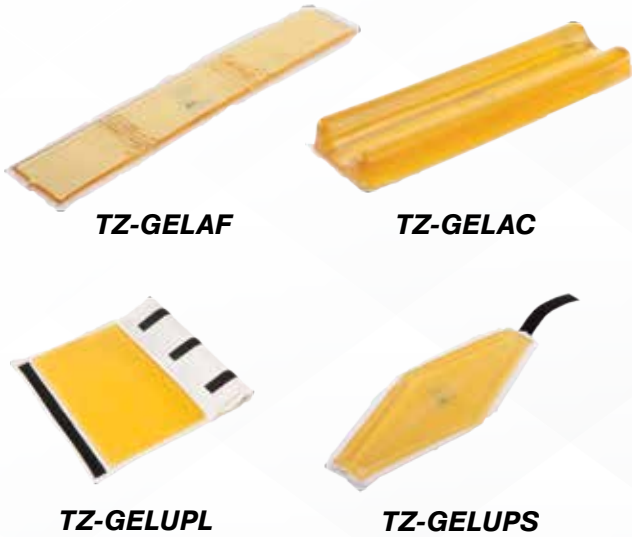

Item Number	Description
TZ-GELAF	Flat Armboard Gel 24" x 4.5" x 0.625"
TZ-GELAC	Gel Contoured Armboard 20" x 5.75" x 2.25"
TZ-GELUPL	Ulnar Nerve Protector, Large 20.13" x 13.75" x 0.25"
TZ-GELUPS	Ulnar Nerve Protector, Small 16.25" x 6.5" x .5"



Item Number	Description
TZ-GELCC	Gel Calf Cup
TZ-GELHC	Gel Heel Cup
TZ-GELHP	Heel Protector Pad
TZ-GELAS	Ankle Stirrup Pad



TZ-GELCC



TZ-GELHC



TZ-GELHP



TZ-GELAS



Item Number	Description
TZ-GELFT	Full Length Table Gel Overlay 20" x 72" x 0.5"
TZ-GELFT3-FT	Gel Foot Table Overlay 20" x 20" x 0.5"
TZ-GELFT3-HD	Gel Head Table Overlay 20" x 10" x 0.5"
TZ-GELFT3-T	Gel Torso Table Overlay 20" x 42" x 0.5"
TZ-GELFT3	3 Piece Table Gel Overlay (Includes: TZ-GELFT3-FT, TZGELFT3-HD, TZ-GELFT3-T)



TZ-GELFT



TZ-GELFT3



TZ-GELFT3-FT



COMFORT HALO



TZ Medical
Sparked by your ideas

The TZ Medical Comfort Halo is designed to enhance safety and comfort for patients undergoing conscious sedation.

The polycarbonate base is compatible with all bed types, allowing it to easily slide underneath the imaging table mattress pad. The steel and vinyl tubing can then be manipulated into a multitude of different draping positions, thereby keeping the drape out of the patient's face and allowing complete visualization of the patient at all times.



For All Procedures Using Conscious Sedation Including:

- PPM/ICD/Bi-V ICD implants
- Chemo/Port placements
- CVP and PICC line insertion
- Antegrade femoral angiography
- Rt heart caths from subclavian approach

Features

- Increases patient comfort by keeping anesthesia drape off of patient's face during conscious sedation
- Ideal for all departments using radiographic imaging and sterile technique
- Offers an unobstructed view of patient during procedure
- The flexible design may be molded to the desired shape or height
- Visual reminder to perform "Time Out", enhancing patient safety/improving staff compliance with JCAHO requirements
- Compatible with any bed type, no arm rails necessary



Item Number	Description	UOM
CZ-009	Comfort Halo - Anesthesia Screen	1 Each



COMFORT CRADLES

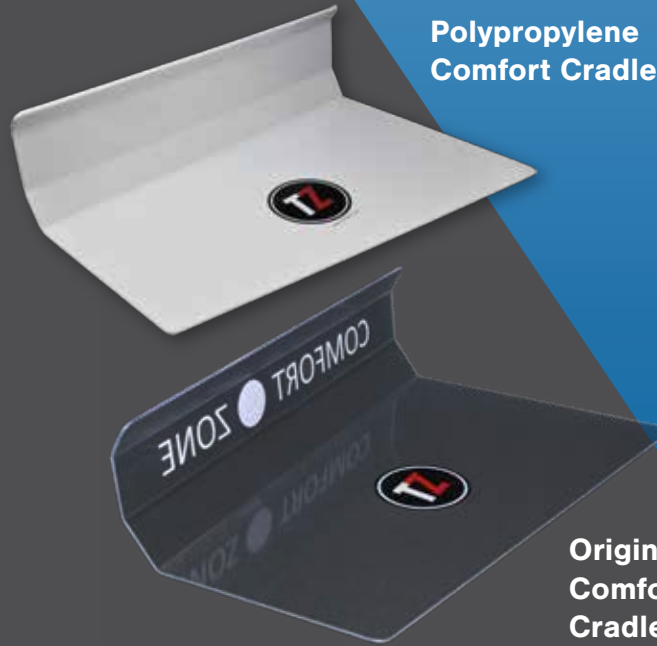

**Polypropylene
Comfort Cradle**

**Original
Comfort
Cradle**

The TZ Medical Comfort Cradle is a versatile product that aids both the patient and the operator during procedures. The cradle's extended width improves comfort, making long procedures more tolerable for the patient. It is available in a clear polycarbonate material or a white polypropylene material, both providing durability and comfort.

The dimensions of the Comfort Cradle provide superior support during vascular procedures when compared with smaller, less robust arm boards.

The Comfort Cradle also offers the ability to position the Flat Detector (or II) in direct contact with the patient in all views, reducing secondary and scatter radiation. The result is superior image quality and reduced radiation exposure for the staff.

Features

- Patient is more accessible to the physician
- Extra wide dimensions for added comfort
- Reduces secondary and scatter radiation
- Options of either durable polycarbonate or polypropylene construction
- Superior image quality
- Comes with a six month warranty

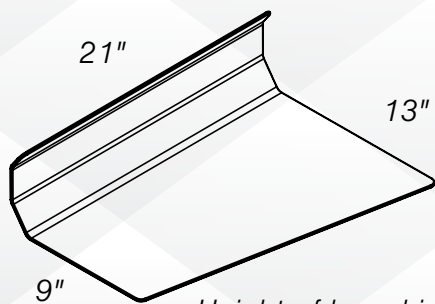

Height of board is 5¾"

Item Number	Description	UOM
CZ-100	Comfort Cradle Kit	Set of 2
CZ-001	Comfort Cradle Replacement Board	1 Each
CZ-100-PP	Polypropylene Comfort Cradle Kit	Set of 2
CZ-001-PP	Polypropylene Comfort Cradle Replacement Board	1 Each
CZ-002	Comfort Cloud Arm Board Padding	Box of 20



DEFIBRILLATION ELECTRODES

Our multi-function electrodes are designed for defibrillation, synchronized cardioversion, external pacing and ECG monitoring. Our full line of electrodes direct-connect to all major brands of defibrillators and include sterile radiotransparent, radiotranslucent, and pediatric options.

Sterile Electrodes



TZ Medical Sterile Defibrillation Electrodes are constructed to adhere and conform to the patient's body, providing superior current distribution, which results in better clinical outcomes.

Our multi-function sterile electrodes are ideal for a variety of procedures, including TAVR, AVR, Mini-Maze, ICD Implants, Laser Lead Extraction and much more. They are designed for defibrillation, synchronized cardioversion, external pacing and ECG monitoring. Compatible with biphasic and monophasic defibrillators, our sterile electrodes offer direct connection to Zoll® defibrillators. We also offer adapters, allowing multiple brands of defibrillators to use the same electrodes.



Features

- Lead wire lengths available in 60" and 120" for maximum convenience and utility
- Hydrogel maintains excellent adhesion to the patient's skin
- Unique edge effect technology disperses energy uniformly, reducing burns
- Radiotransparent and radiotranslucent options available

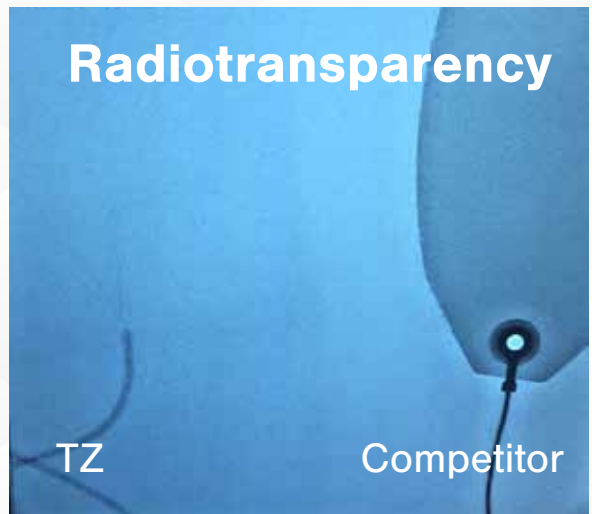

Pad Placement Guide



TZ Medical
Sparked by your ideas

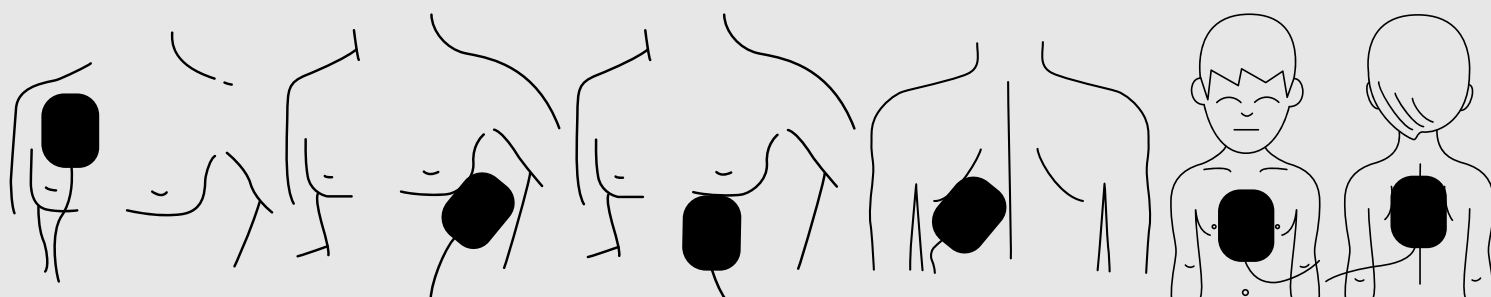

Lead Wire Length

TZ Sterile P-121-T1, P-122-T1: 120"

TZ Sterile P-224-Z1, P-224-T1: 60"

Competitor Electrodes: 24"

**Universal T1
Connector**

**Zoll® Z1
Connector**



Product Description	Size	Medtronic®	Universal ¹	Zoll® ²
Adult Radiotranslucent, Sterile	A	P-121-T1 PAD 1111 Adapter*	P-121-T1	P-121-T1 PAD 101PD Adapter*
Adult Radiotransparent Pads and Leadwires, Large Posterior Pad, Sterile	A/B	P-224-T1 PAD 1111 Adapter*	P-224-T1	P-224-Z1
Pediatric Radiotranslucent Pads, Sterile	C	P-122-T1 PAD 1111 Adapter*	P-122-T1	P-122-T1 PAD 101PD Adapter*

***Adapters are reusable**

For Pediatric Use: ≥10kg (22lbs)
AED or AED Mode: ≥25kg (55lbs) ≥8 years old

1 – T1 Anderson models allow for multiple brand of defibrillators to use the same electrodes. (adapter needed)
2 – Z1 Zoll Models are comparable to Zoll® multifunction electrodes.

Pad Dimensions:

A=6"x4.25" B=6"x9" C=4.25"x2.876"

**To see our full line of
products, visit us at
TZMedical.com**

ITEM NUMBER INDEX

NEUROSURGERY

Distraction Pins

12mm Titanium Distraction Pin Blue
Box of 10
Item# DP-12-TB

14mm Titanium Distraction Pin Yellow
Box of 10
Item# DP-14-TY

16mm Titanium Distraction Pin Green
Box of 10
Item# DP-16-TG

18mm Titanium Distraction Pin Purple
Box of 10
Item# DP-18-TP

Distraction Pin Accessories

Caspar Screwdriver Universal
Item# DP-S

Caspar Distractor Right
Item# DP-72-CDR

Caspar Distractor Left
Item# DP-74-CDL

Skull Pins

Box of 10
Item# SP-001

Suction Tips

Box of 50
Suction Tips 6F, 8cm
Item# STIP-1011-08
Suction Tips 6F, 11cm
Item# STIP-1011-11
Suction Tips 8F, 8cm
Item# STIP-1013-08
Suction Tips 8F, 11cm
Item# STIP-1013-11
Suction Tips 10F, 8cm
Item# STIP-1015-08
Suction Tips 10F, 11cm
Item# STIP-1015-11
Suction Tips 10F, 23cm
Item# STIP-1015-23
Suction Tips 12F, 8cm
Item# STIP-1017-08
Suction Tips 12F, 11cm
Item# STIP-1017-11
Suction Tips 12F, 23cm
Item# STIP-1017-23
Suction Tips 14F, 8cm
Item# STIP-1019-08
Suction Tips 14F, 11cm
Item# STIP-1019-11
Suction Tips 14F, 23cm
Item# STIP-1019-23

SAFETY & EFFICIENCY

Pro11 Headset

Pro11 Base Station
Item# TZ-Q-P11BS

Pro11 Charger
Item# TZ-Q-P11CH

Pro11 Headset (w/Battery & Headband)
Item# TZ-Q-P11HS

Battery for Headset
Item# TZ-Q-P11BAT

Headband for Headset
Item# TZ-Q-P11HB

Hygiene Covers
Box of 100
Item# TZ-Q-RH7HC

SAFETY & EFFICIENCY CONT.

Pro11 Headset Cont.

Ear Cushions
Box of 10
Item# TZ-Q-RH7EC

Battery Charger Shelf
Item# TZ-Q-P10SHELF

Anti-Fatigue Mats

OR Durable ¾" Thick, Blue Bio-foam®,
Size 18x24
Item# GP-18X24

OR Durable ¾" Thick, Blue Bio-foam®,
Size 20x32
Item# GP-20X32

OR Durable ¾" Thick, Blue Bio-foam®,
Size 20x48
Item# GP-20X48

OR Durable ¾" Thick, Blue Bio-foam®,
Size 30x72
Item# GP-30X72

PATIENT POSITIONING

Pannus Retention System

PRS-02
Box of 10
Item# CZ-PRS-02 (2 Pads and 1 Strap)
PRS-04
Box of 10
Item# CZ-PRS-04 (4 Pads and 2 Straps,
Sterile)

Cervical Retention System

PRS-06
Box of 10
Item# CZ-PRS-06 (4 Pads and 2 Straps)

Lumbar Retention System

PRS-09
Box of 10
Item# CZ-PRS-09 (9 Pads and 3 Straps)

SoftGels

Head Gels

Adult Gel Donut
8"OD x 3"ID x 1.75"H
Item# TZ-GELDA

Extra Deep Donut
8"OD x 3"ID x 3"H
Item# TZ-GELDA-3

Pediatric Donut
5.5"OD x 2.25"ID x 1.25"H
Item# TZ-GELPD

Neo Natal Donut
3.07"OD x 1.68"ID x .81"H
Item# TZ-GELND

Adult Horseshoe Donut
8"OD x 3"ID x 1.75"H
Item# TZ-GELHRS

Pediatric Horseshoe Donut
5.5"OD x 2.25"ID x 1.25"H
Item# TZ-GELPHR

Supine Headrest
11"OD x 9.5"ID x 2.625"H
Item# TZ-GELSHP

Head Pad
11"OD x 9.5"ID x 3.5"H
Item# TZ-GELHDP

PATIENT POSITIONING CONT.

SoftGels Cont.

Body Positioners

Gel Patient Positioner 10"
10" x 4.5" x 2" (Sandbag Style)
Item# TZ-GELPP10

Gel Patient Positioner 14"
14" x 4.5" x 2" (Sandbag Style)
Item# TZ-GELPP14

Gel Patient Positioner 18"
18" x 4.5" x 2" (Sandbag Style)
Item# TZ-GELPP18

Flat Bottom Gel Chest Roll 12"
12" x 4" x 4"
Item# TZ-GELCR4-12

Flat Bottom Gel Chest Roll 16"
16" x 4" x 4"
Item# TZ-GELCR4-16

Flat Bottom Gel Chest Roll 20"
20" x 4" x 4"
Item# TZ-GELCR4-20

Flat Bottom Gel Chest Roll 12"
12" x 6" x 6"
Item# TZ-GELCR6-12

Flat Bottom Gel Chest Roll 16"
16" x 6" x 6"
Item# TZ-GELCR6-16

Flat Bottom Gel Chest Roll 20"
20" x 6" x 6"
Item# TZ-GELCR6-20

Arm Gels & Ankle & Foot Gels

Flat Armboard Gel
24" x 4.5" x 0.625"
Item# TZ-GELAF

Gel Contoured Armboard
20" x 5.75" x 2.25"
Item# TZ-GELAC

Gel Ulnar Protector, Large
20.13" x 13.75" x .25"
Item# TZ-GELUPL

Gel Ulnar Protector, Small
16.25" x 6.5" x 0.5"
Item# TZ-GELUPS

Gel Calf Cup
Item# TZ-GELCC

Gel Heel Cup
Item# TZ-GELHC

Heel Protector Pad
Item# TZ-GELHP

Ankle Stirrup Pad
Item# TZ-GELAS

Table Gels

Full Length Table Gel Overlay
20" x 72" x 0.5"
Item# TZ-GELFT

Gel Foot Table Overlay
20" x 20" x 0.5"
Item# TZ-GELFT3-FT

Gel Head Table Overlay
20" x 10" x 0.5"
Item# TZ-GELFT3-HD

Gel Torso Table Overlay
20" x 42" x 0.5"
Item# TZ-GELFT3-T

3 Piece Table Gel Overlay
Includes: Gel Foot Table Overlay, Gel Head
Table Overlay, Gel Torso Table Overlay
Item# TZ-GELFT3

ITEM NUMBER INDEX CONT.

PATIENT POSITIONING CONT.

Comfort Halo

Dimensions: 23" x 14.5"

Item# CZ-009

Comfort Cradle

Dimensions: 21"x 13"x 9"

Item# CZ-100 (Set of 2)

Item# CZ-001 (1 Each)

ELECTRODES

Sterile Electrodes

Sterile Radiotranslucent Electrode

Box of 10

Item# P-121-T1

Sterile Radiotransparent Electrode with

Large Back Pad

Box of 10

Item# P-224-T1

Item# P-224-Z1

Sterile Radiotranslucent Pediatric

Electrode

Box of 10

Item# P-122-T1

For additional information or questions
about ordering call: 800.944.0187

or visit us at

www.tzmedical.com

FIND OUT MORE



tzmedical.com



800.944.0187



info@tzmedical.com

16141 R3.2



TZ Medical
Sparked by your ideas